

USER MANUAL:
Sun/wind device for 1 motor

593.K.RS.00

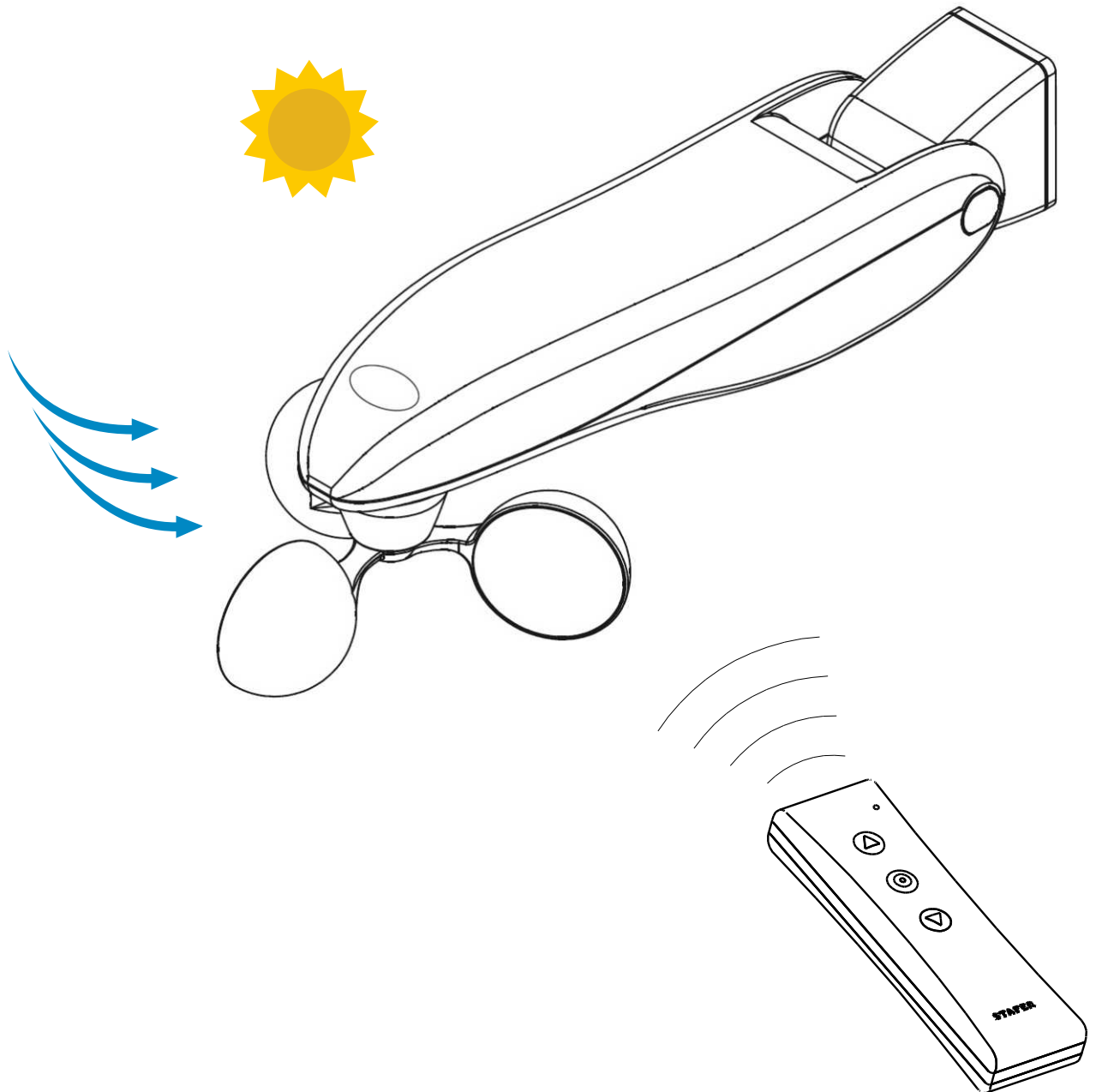

SIRIO / SIRIO DUO

Dear customer, thank you for purchasing a STAFER product. This guide contains information about the product use. Before the product installation and use, please read carefully this guide and keep it for future reference.

593.K.RS.00 is a sun/wind device studied to command tubular motor with mechanical limit switch powered by main voltage and it is suitable to command awnings, roller shutters or similar.

593.K.RS.00 permits to command the automatic upward movement of the blinds connected to the motor when the wind exceeds the set threshold and to command an automatic lowering when the intensity of sun exceeds the threshold set. These thresholds are set by the factory, but they can be adjusted according to the needs.

Warning



This sensor does not protect awning in case of strong and sudden gusts of wind.

In case of weather hazards of this type, make sure that the curtains remain closed!

STAFER S.p.A. declines all responsibility for damage incurred due to weather events not detected by the device.



Any other use beyond the field defined by STAFER S.p.A. is prohibited and involves, as well as the failure to comply with instructions provided in this guide, the cancellation of STAFER S.p.A. liability and warranty.

The installer, after the installation of the product, must teach the end user about the working way of the automation and provide him with the user manual.

Technical specifications

✓ Power supply:	120 o 230 Vac, 50/60 Hz
✓ Dimensions:	236 x 54 x 73 mm
✓ Weight:	200 gr
✓ Working temperature:	from -20 to +55 °C
✓ Wind threshold:	from 10 to 35 Km/h
✓ Sun threshold:	from 1 to 45 Klux
✓ Working frequency:	433.42 Mhz
✓ Memorizable radio codes:	15
✓ Range (estimate):	100m outdoor, 20m indoor

Index

01 Warning	pag. 02
02 Assembly instruction	pag. 03
03 Electrical connection	pag. 04
04 Interfacing with home automation control unit	pag. 05
05 How to memorize the first handheld transmitter	pag. 06
06 Operating logic of command buttons	pag. 06
07 Memorization/deletion of a transmitter	pag. 07
08 Wind sensor	pag. 08
09 Sun function	pag. 09
10 Anemometric Test function	pag. 09
11 Reset	pag. 10
12 FAQ	pag. 10

Notes on radio systems

It is advisable **to avoid using radio systems in areas with strong interference** (for example, near police stations, airports, ports, hospital, etc.). A technical inspection is in any case advisable before installing any radio system in order to identify sources of interference.

Radio systems can be used where possible disturbances or malfunctioning of the transmitter or the receiver do not cause a risk factor, or if the risk factor is cancelled by suitable safety systems.

The presence of radio device operating on the same transmission frequency (**433,42 MHz**) can interfere with the radio receiver of the motor and so reduce the range of the system and limit the functionality of the installation.



Environmental conservation!!

STAFER uses packaging recyclable materials. Dispose materials on the proper containers, complying with the law in force in your locality. This product may have substances that are polluting for the environment and dangerous for the health.

At the end of the product life cycle, carefully comply with the waste disposal rules. It is strictly forbidden to dispose the product on the domestic waste.



01.1 WARNING FOR SAFETY

- ✓ Incorrect installation can cause serious injuries.
- ✓ Keep these instructions for future maintenance work and disposal of the product.
- ✓ All the product installation, connection, programming and maintenance operations must be carried out only by a qualified and skilled technician, who must comply with laws, provisions, local regulations and the instructions given in this manual.
- ✓ The wiring must comply with current CEI standards. The final electrical system must be created only by the electrician.
- ✓ Some applications require hold-to-run operation and can exclude the use of radio controls or require particular safety devices.
- ✓ To prevent potentially dangerous situations, check the operating condition of the roller shutter/awning regularly.

01.2 WARNING FOR INSTALLATION

- ✓ Read the technical specifications on the paragraph "Technical specifications" to evaluate the operating limits of the product.
- ✓ Before installing the product, check the compatibility with the associated devices and accessories.
- ✓ The motor connected to the device must be of the type "mechanical limit switches", without any electronic control ; The motor must be of adequate power to the load (check the nameplate data on the motor).
- ✓ Check that the package is intact and has not been damaged in transit.
- ✓ A heavy shock and the use of unsuitable tools can cause the damage of the external or internal parts of the product.
- ✓ Do not pierce or tamper with the product in any way. Do not modify or replace parts without the manufacturer's permission.
- ✓ Check that the place chosen for the installation of the product permits the same wind exposure of the blind to be automated.
- ✓ Check that the place chosen for the installation is made by solid material and can ensure a stable fixation.
- ✓ If there are several radio appliances in the same system, they must not be less than 1,5m apart.
- ✓ Do not install the product near metal surfaces.
- ✓ Do not install the product near heat sources (such as chimneys, etc....).
- ✓ Adjust the inclination of the device to have the blades positioned horizontally.
- ✓ The blades for the wind detections must be faced downward. The blades must be free to rotate without obstruction.
- ✓ Check that the device is placed in a protected position from accidental impact with other object (e.g. branches, etc.).
- ✓ The power cable must be positioned in such a way that it does not come into contact with moving parts.
- ✓ Do not use abrasive or solvent product for cleaning the device; do not clean using water or high-pressure cleaners.
- ✓ For your safety, do not work near the winding roller while the motor is powered.

01.3 WARNING FOR USE

- ✓ The product is not intended to be used by persons (including children) with reduced physical, sensory or mental capabilities, or lack of experience and knowledge, unless they are supervised or given instructions about the product way of use by a person responsible for their safety.
- ✓ Check the automation during the movement and keep people at a safe distance, until the movement ends.
- ✓ Do not allow children to play with the appliance or with the fixed control devices.
- ✓ Do not operate the blind when maintenance operations are being carried out (e.g. window cleaning, etc.). If the control device is automatic, disconnect the motor from the power line.

02. ASSEMBLY INSTRUCTIONS

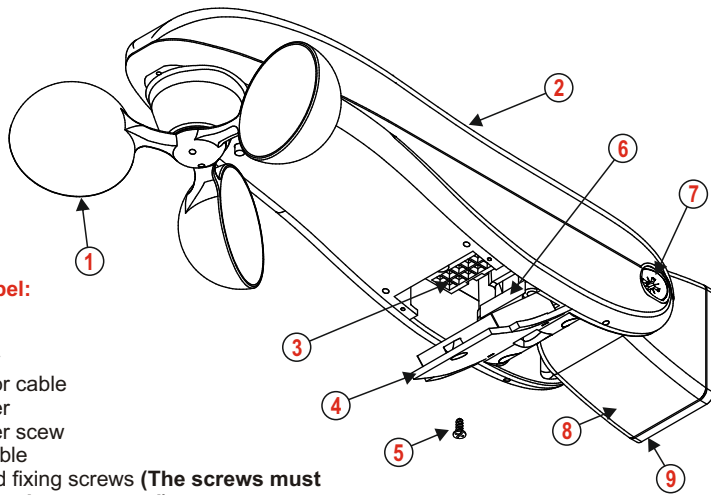

Components label:

- (1) Blades
- (2) Sensor body
- (3) Connector for cable
- (4) Closing cover
- (5) Closing cover screw
- (6) Retaining cable
- (7) Adjusting and fixing screws **(The screws must never be completely unscrewed)**
- (8) Wall fixing
- (9) Wall support
- (10) Screws cover

02.1 BUTTON AND LED DIAGRAM

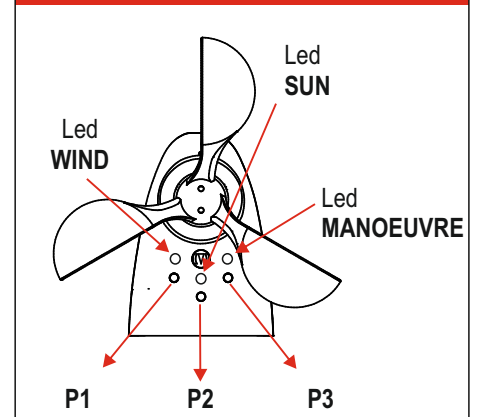

02.2 FIXING SYSTEM

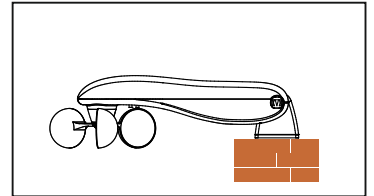
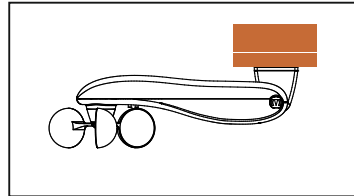
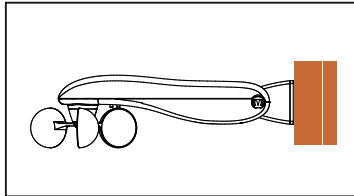
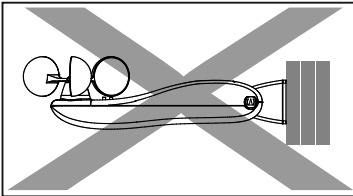

02.3 MOUNTING INSTRUCTIONS



WARNING: Adjusting and fixing screws (7) must never be completely unscrewed

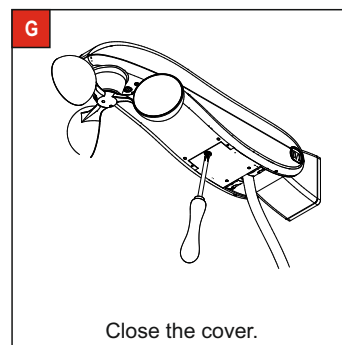
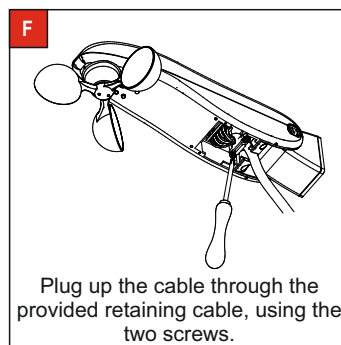
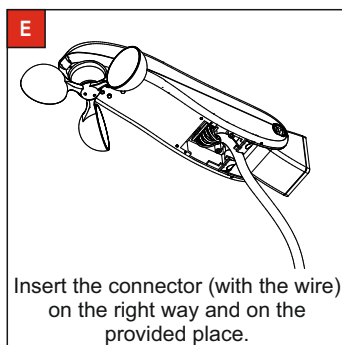
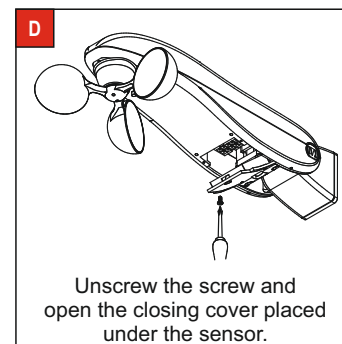
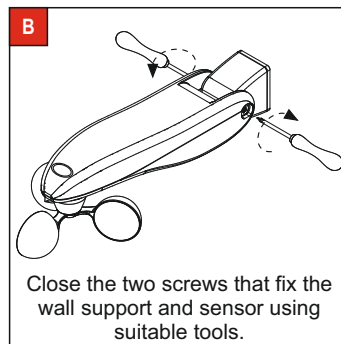
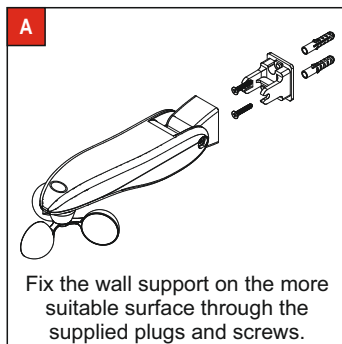

Notes:

- ✓ the product has been studied to be installed with the blades facing downward. Moreover, the body sensor must be adjusted horizontally (the use of a bubble level can simplify the operation); the wall bracket with tilting angle $\pm 90^\circ$ allows to mount the sensor even on no-vertical structures.
- ✓ the hole interaxis is 30 mm.

03. ELECTRICAL CONNECTION



- ✓ Make connections with power supply disconnected.
- ✓ Check that the power supply does not depend from electrical circuits for lighting.
- ✓ Always connect the motor to the grounding system (yellow/green).
- ✓ The supply line must be equipped with a circuit breaker. The supply line must be fitted with a device with a voltage category III, i.e. the distance between the contacts must be of 3,5 mm at least.
- ✓ The product doesn't provide any protection against overloads or short circuits. Provide the supply line with an adequate protection to the load, for example a fuse of maximum value 3,15A.
- ✓ The section of the connecting cables must be proportionate to their length and to the absorption of the load, and in any case not less than 1,5 mm.
- ✓ **You must use buttons with spring return ("hold to run" type), do not use buttons with maintained position.**
- ✓ Command buttons are connected to the main voltage, so they must be properly insulated and protected.
- ✓ **Once the electrical connections are finished, bring the motor/motors to the intermediate position and check that in the "wind alarm" condition the module commands the upward movement to the motor/motors (to exit from the "wind alarm", press any buttons P1, P2 or P3).**

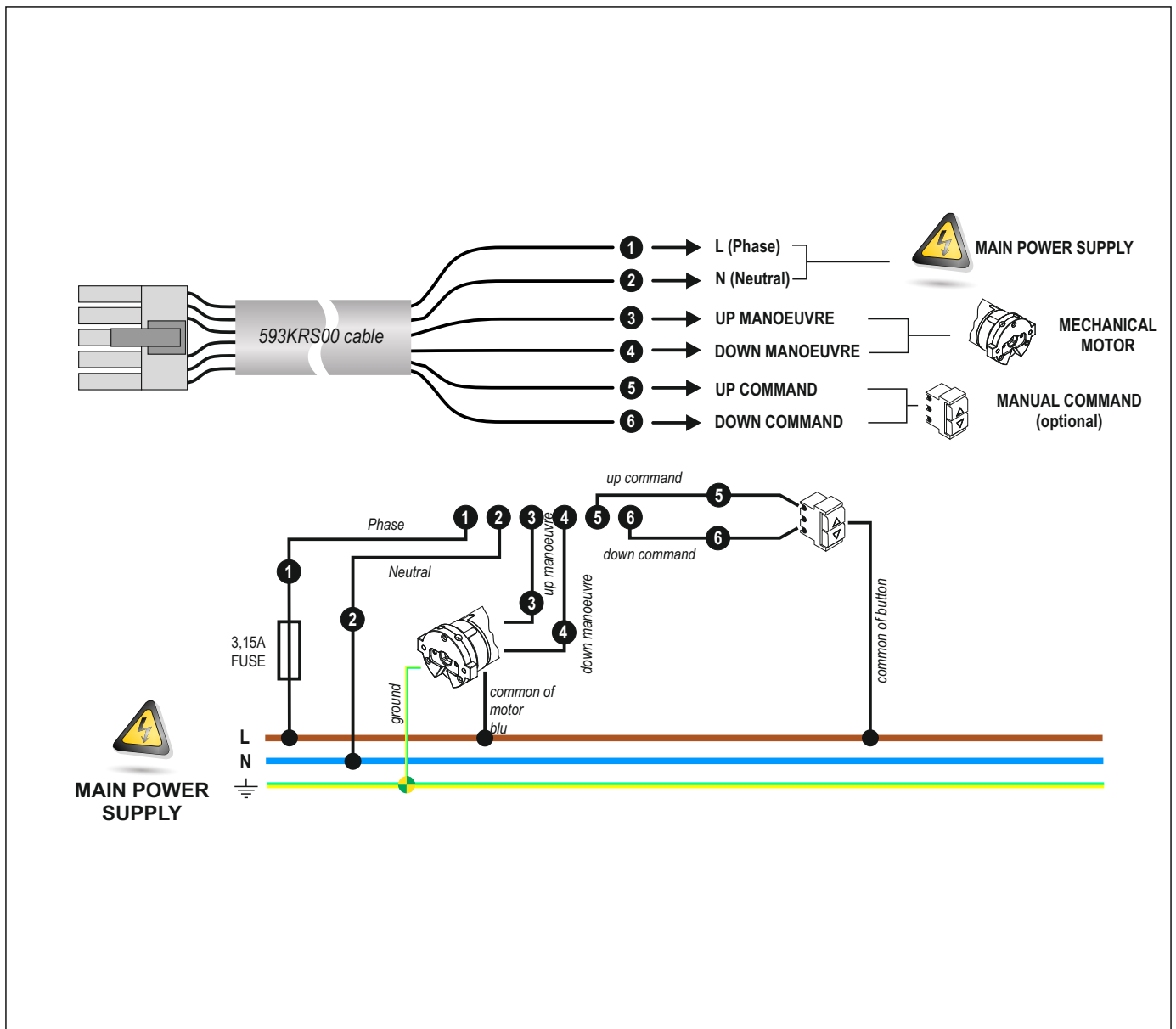

04. INTERFACING WITH HOME AUTOMATION CONTROL UNIT

- ✓ This device can be interfaced to the most widespread home automation control unit through the wires of the command buttons (it is still necessary to check beforehand the compatibility, assessing whether the home automation control unit is able to provide appropriate signals to the device).
- ✓ **Caution:** Before making any connections between your device and the home automation control unit you need to choose the operating logic of the buttons that will best suit your home automation system ("pulse" or "hold to run" logic, see section "Operating logic of the command buttons").
- ✓ If you select the **"pulse"** operating logic (factory setting), the home automation control unit must be able to generate timed signals on the contacts for the buttons (greater than 0.5 sec to start the manoeuvre, less than 0,5 sec to stop the manoeuvre). If your home automation system does not have this feature, you must set the device to work in **"hold to run"** logic.
- ✓ Note that the contacts OPEN and CLOSE, belonging to the home automation control unit and connected to the wires of the control buttons on the device, must close on phase.

05. HOW TO MEMORIZE THE FIRST HANDHELD TRANSMITTER

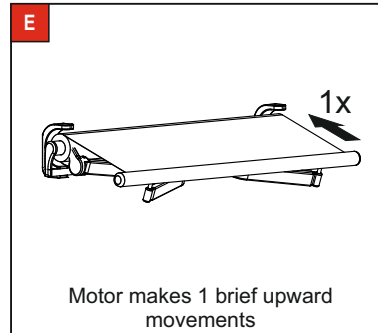
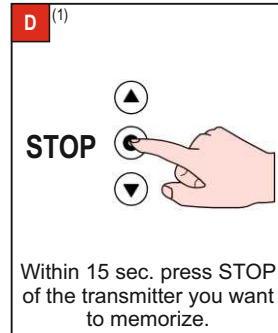
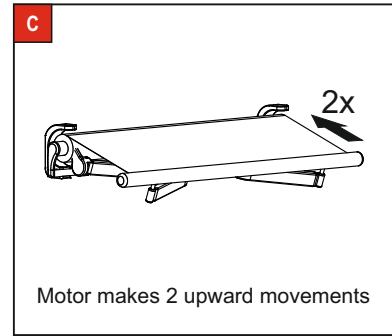
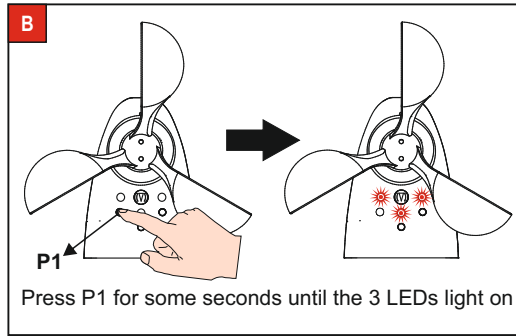
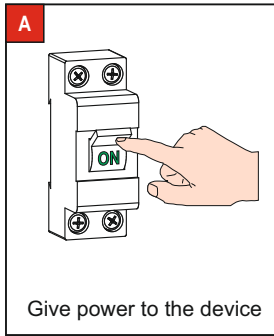

Note:

- ✓ (1): if the button is not pressed within 15 seconds, the motor exits the programming and signals it with 2 downward movements
- ✓ If you have installed the control buttons, you can store the transmitter through the procedure called "Memorization / Deletion of a transmitter via command buttons"
- ✓ The memorization of additional transmitters can be carried out in the same way or, more conveniently, by using a portable transmitter already memorized or the command buttons (see section "Memorization/Deletion of a transmitter")

06. OPERATING LOGIC OF COMMAND BUTTONS

This device provides the possibility to choose one of the following operating logics for the command buttons :

“Pulse” logic

This is the default mode from the factory. The motor moves up (down) if the relevant contact is closed on phase for at least 0.5 sec, the motor will stop if any one of the two contacts is closed briefly (less than 0.5 sec).

“Hold to run” logic

The motor moves up (down) if the relevant contact is closed on phase for at least 0.5 sec, the motor stops when contact is open.

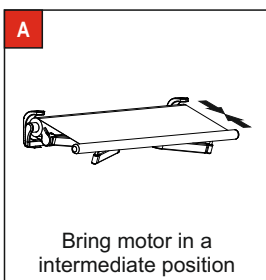

B.1 USING AN HAND-HELD TRANSMITTER Mod.594

01. Select the correct radio channel and bring the motor on the intermediate position.
02. Press **MENU** for about 5 seconds. **rS** appears on the display.
03. Press 1 time **PREV** and 8 times **NEXT**. 18 appears on the display
04. Press 1 time **STOP**. The receiver signals the current value.
Hold to run: ▲ 1 (1 short upward movement)
Pulse: ▼ 1 (1 short descent movement)
05. Press **PREV** for logic «pulse» (**Of** appears on the display) or **NEXT** for logic «hold to run» (**On** appears on the display). Factory set is **Of**.
06. Press 1 time **STOP**. The receiver signal the new value.
Hold to run: ▲ 1 - **Pulse:** ▼ 1

B.2 USING AN HAND-HELD TRANSMITTER Mod.593

01. Bring the motor to the intermediate position. .
02. While press **STOP** also press **PROG** for until the LED lights up.
03. Press once on **UP** and 8 times **DOWN**.
04. Press once on **STOP**. The motor shows the current value.
Hold to run: ▲ 1 (1 short upward movement)
Pulse: ▼ 1 (1 short descent movement)
05. Press **DOWN** for logic «pulse» or **UP** for logic «hold to run»
06. Press 1 time **STOP**. The receiver signal the new value.
Hold to run: ▲ 1 - **Pulse:** ▼ 1

07. MEMORIZATION/DELETION OF A TRANSMITTER

To memorize a transmitter, in addition to the onboard buttons (see section 05, "How to memorize the first handheld transmitter"), you can use the command buttons or, for added convenience, an already stored handheld transmitter.

If the transmitter is already stored in the device, by performing the procedure the transmitter is deleted from the memory.

07.1 USING COMMAND BUTTONS

A

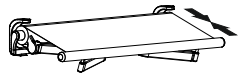

Bring motor in a intermediate position

B

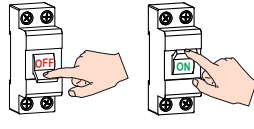

Switch OFF power supply, wait 2 seconds and switch ON power supply.

C ⁽¹⁾

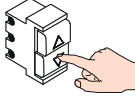

10 x DOWN

Within 15 seconds press DOWN 10 times.

D

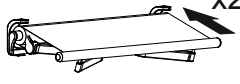

Motor makes 2 upward movements

E ⁽²⁾ WITHIN 15 SECONDS PRESS:

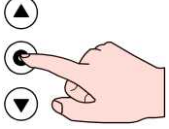
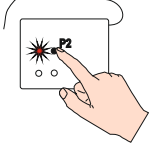
HANDHELD TRANSMITTER	RAIN SENSOR
 <p>STOP</p>	 <p>P2</p>

F

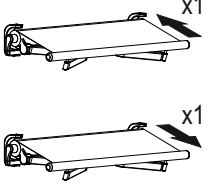

MEMORIZED

DELETED

The motor signals the operation performed

Notes:

- ✓ (1): the button must be pressed briefly (less than 0.5 sec) and in rapid succession (max 1 seconds between each press and the next).
- ✓ (2): If the button is not pressed within 15 seconds, the motor exits the programming and signals it with 2 downward movements
- ✓ The device can memorize up to 15 radio codes (including rain sensors) for each motor. The condition of 'memory full' is reported with 2 downward movements
- ✓ If the motor has memorized a single hand-held transmitter, it can't be deleted (the non-cancellation is indicated by two downward movements).

07.2 USING AN HAND-HELD TRANSMITTER

A

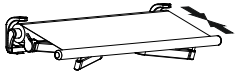

Bring motor in a intermediate position

B

By mod. 594

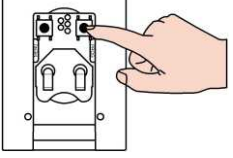

By mod. 593

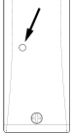

Press and hold PROG of a transmitter already memorized for about 5 sec.

C

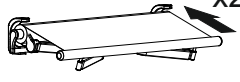

Motor makes 2 upward movements

D ⁽¹⁾ WITHIN 15 SECONDS PRESS:

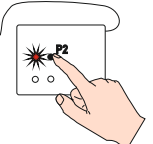
HANDHELD TRANSMITTER	RAIN SENSOR
 <p>STOP</p>	 <p>P2</p>

E

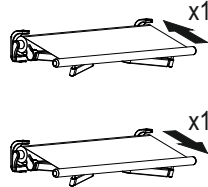

MEMORIZED

DELETED

The motor signals the operation performed

Notes:

- ✓ (1): If the button is not pressed within 15 seconds, the motor exits the programming and signals it with 2 downward movements
- ✓ The device can memorize up to 15 radio codes (including rain sensors) for each motor. The condition of 'memory full' is reported with 2 downward movements
- ✓ If the motor has memorized a single hand-held transmitter, it can't be deleted (the non-cancellation is indicated by two downward movements).

08. WIND SENSOR

If the wind speed is above the set threshold for at least 3 seconds, an upward movement is commanded to protect the awning (wind alarm). During this phase **all manual commands are disabled**. The device exits from the "wind alarm" if the wind speed keeps below the set threshold for at least 8 minutes. The wind threshold is varying from 5 km/h to 35 km/h. The factory sets the wind threshold at 15 Km/h.

08.1 CHANGING THE WIND THRESHOLD USING THE ONBOARD BUTTONS

A

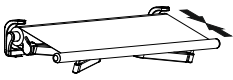

Bring motor in a intermediate position

B

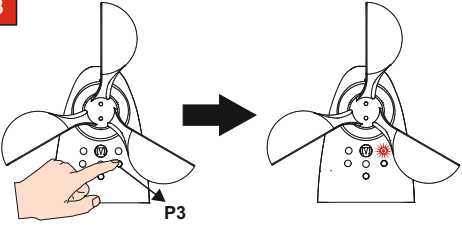

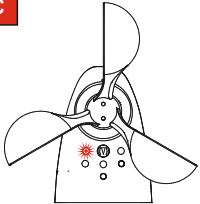

Press P3 until LED 3 lights ON

C

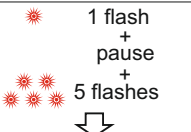

LED 3 turns off and LED 1 indicates the current value of the wind threshold

EXAMPLES:

 $10 + 5 = 15 \text{ Km/h}$	 \downarrow 5 Km/h
---	---

D ⁽¹⁾ TO ADJUST THE WIND THRESHOLD:
Press P1 to set the tens and P3 to set the units

EXAMPLE:

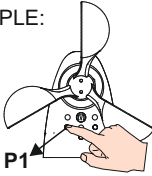
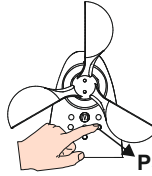
1 X	+	8 X	=	18 Km/h
				
\downarrow		\downarrow		
10	+	8	=	18 Km/h

E

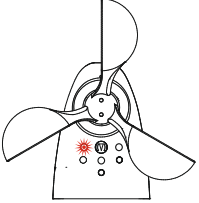

1 flash + pause + 8 flashes
 \downarrow
10 + 8 = 18 Km/h

The device signals the new value and exits from programming

If the value is the desired one, wait 10 seconds: the device signals again the value and exits from the programming.

Notes:

- ✓ (1) : press the buttons within 10 seconds from the last flash of LED 1. The buttons must be shortly pressed, around 1 second between two pressures. Press the buttons the same number of time of the desired value: e.g. press 8 times P3 to set 8 Km/h; press 2 times P1 and 8 times P3 to set 28 Km/h.
- ✓ If you try to set a wind threshold lower than 5 Km/h or higher than 35 Km/h, the device signals the error with the lighting of the 3 leds for 3 times.

08.2 CHANGING THE WIND THRESHOLD USING AN HANDHELD TRANSMITTER

A

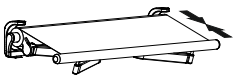

Bring motor in a intermediate position

B.1 USING AN HAND-HELD TRANSMITTER Mod.594	B.2 USING AN HAND-HELD TRANSMITTER Mod.593
<ol style="list-style-type: none"> 01. Select the correct radio channel and bring the motor on the intermediate position. 02. Press MENU for about 5 seconds. rs appears on the display. 03. Press 1 time NEXT. 01 appears on the display. 04. Press 1 time STOP. The receiver signal the current value. Examples: if threshold = 08 Km/h: ▲ 8 (8 short movements) if threshold = 15 Km/h: ▲ 1 - pause - ▲ 5 if threshold = 30 Km/h: ▲ 3 - pause - ▲ 1 long 05. Using PREV and NEXT to set the new value. (from 5 Km/h at 35 Km/h. From factory set to 15 Km/h). Examples: for threshold 08 Km/h: (0 time PREV) - 8 times NEXT for threshold 15 Km/h: 1 time PREV - 5 times NEXT for threshold 30 Km/h: 3 times PREV - (0 time NEXT) 06. Press 1 time STOP. The receiver signal the new value. 	<ol style="list-style-type: none"> 01. Bring the motor to the intermediate position. 02. While press STOP also press PROG for until the LED lights up. 03. Press once DOWN. 04. Press once STOP. The motor shows the current value Examples: if threshold = 08 Km/h: ▲ 8 (8 short movements) if threshold = 15 Km/h: ▲ 1 - pause - ▲ 5 if threshold = 30 Km/h: ▲ 3 - pause - ▲ 1 long 05. Using PREV and NEXT to set the new value. (from 5 Km/h at 35 Km/h. From factory set to 15 Km/h). Examples: for threshold 08 Km/h: (0 time PREV) - 8 times NEXT for threshold 15 Km/h: 1 time PREV - 5 times NEXT for threshold 30 Km/h: 3 times PREV - (0 time NEXT) 06. Press 1 time STOP. The receiver signal the new value.

08.3 VISUAL SIGNALS ASSOCIATED WITH THE WIND SENSOR

LED Wind → **RED**: the wind is above the threshold.

LED Wind → **OFF**: the wind is below the threshold.

LED Manoeuvre → **QUICK FLASHES** } : the module is in wind alarm and the manual commands are disabled.
LED Sun → **RED**

08.4 FORCED EXIT FROM THE WIND ALARM

During the installation phase, it is possible to exit from "wind alarm" without waiting 8 minutes below the threshold, shortly pressing (less than 1 sec) any of the buttons **P1**, **P2**, **P3** on the device.

09. SUN FUNCTION

If the intensity of the sun is above the set threshold for at least 2.5 minutes, an automatic downward manoeuvre is performed; if the intensity of the sun is below the set threshold for at least 18 minutes, an automatic upward manoeuvre is performed. Once an automatic downward manoeuvre for the presence of the sun is performed, the next automatic manoeuvre performed by the device will be an upward movement for absence of sun and so on. The user can in any case operate the awning, the manual control don't affects the operating logic of the sun sensor. The sun threshold is variable to 1 to 45 Klux. The factory sets the sun threshold to 16 Klux.



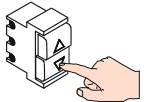
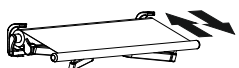
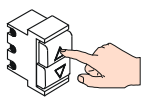
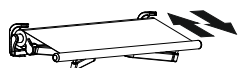

09.1 ACTIVATION/DEACTIVATION OF SUN FUNCTION THROUGH COMMAND BUTTONS

<p>A ⁽¹⁾ TO ACTIVATE:</p>  <p>4 x DOWN</p> <p>Press 4 times DOWN</p>	<p>B</p>  <p>The motors indicate that the setting has been changed.</p>	<p>A ⁽¹⁾ TO DISABLE:</p>  <p>4 x UP</p> <p>Press 4 times UP</p>	<p>B</p>  <p>The motors indicate that the setting has been changed.</p>
--	---	---	---

Note:
 ✓ (1): the button must be pressed briefly (less than 0.5 sec) and in rapid succession (max 1 seconds between each press and the next)

09.2 ACTIVATION/DEACTIVATION OF SUN FUNCTION THROUGH HANDHELD TRANSMITTER

It's possible to activate / deactivate the "Sun" function using a remote control stored in the device.

<p>USING AN HAND-HELD TRANSMITTER Mod.594</p> <p>  Select the channel (excluded «SE» sequencer channel)</p> <p> Press SUN until the state of the YELLOW LED varies (about 2 seconds)</p> <p> YELLOW LED LIGHT ON/OFF: «sun/automatic lowering» function active / off</p>	<p>USING AN HAND-HELD TRANSMITTER Mod.593</p> <p>If the LED flashes during transmission, the "sun function" is inactive. If the LED stays ON during transmission, the "sun function" is active.</p> <p>To enable/disable the "sun function" press STOP and UP together for 3 seconds.</p>
---	--

09.3 SUN THRESHOLD ADJUSTING THROUGH THE BUTTONS ON THE DEVICE

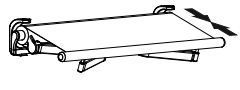
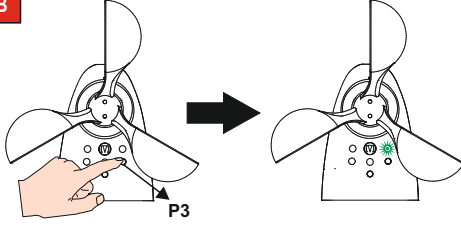
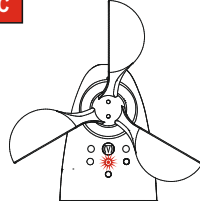
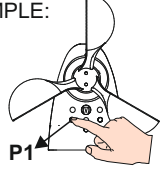
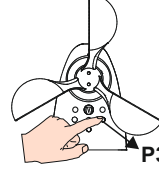
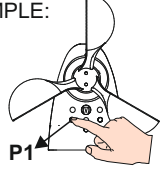
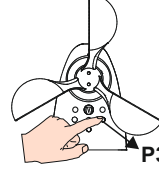
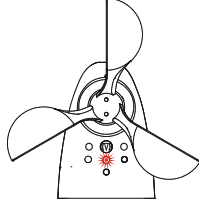
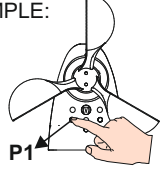
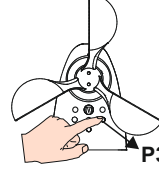
<p>A</p>  <p>Bring the motor in an intermediate position</p>	<p>B</p>  <p>Press P3 until LED 3 lights up red first and then green. Release the button</p>	<p>C</p>  <p>LED 3 turns off and LED 2 indicates the current sun threshold</p> <p>EXAMPLES:</p> <table border="1"> <tr> <td> <p>1 flash + pause + 5 flashes</p> <p>↓</p> <p>10 + 5 = 15 Klux</p> </td> <td> <p>5 flashes</p> <p>↓</p> <p>5 Klux</p> </td> </tr> </table>	<p>1 flash + pause + 5 flashes</p> <p>↓</p> <p>10 + 5 = 15 Klux</p>	<p>5 flashes</p> <p>↓</p> <p>5 Klux</p>			
<p>1 flash + pause + 5 flashes</p> <p>↓</p> <p>10 + 5 = 15 Klux</p>	<p>5 flashes</p> <p>↓</p> <p>5 Klux</p>						
<p>If the value is the desired one, wait 10 seconds: the device signals again the value and exits from the programming.</p>	<p>D ⁽¹⁾ TO ADJUST THE SUN THRESHOLD: Press P1 to set the tens and P3 to set the units</p> <p>EXAMPLE:</p> <table border="1"> <tr> <td> <p>1 X</p>  <p>↓</p> <p>10</p> </td> <td>+</td> <td> <p>8 X</p>  <p>↓</p> <p>8</p> </td> <td>=</td> <td> <p>18 Klux</p> </td> </tr> </table>	<p>1 X</p>  <p>↓</p> <p>10</p>	+	<p>8 X</p>  <p>↓</p> <p>8</p>	=	<p>18 Klux</p>	<p>E</p>  <p>The device signals the new value and exits from the programming</p> <p>1 flash + pause + 8 flashes</p> <p>↓</p> <p>10 + 8 = 18 Klux</p>
<p>1 X</p>  <p>↓</p> <p>10</p>	+	<p>8 X</p>  <p>↓</p> <p>8</p>	=	<p>18 Klux</p>			

Notes:
 ✓ (1): press the buttons within 10 seconds from the last flash of LED 2. The buttons must be shortly pressed, around 1 second between two pressures. Press the buttons the same number of time of the desired value: e.g. press 8 times P3 to set 8 Klux; press 2 times P1 and 8 times P3 to set 28 Klux.
 ✓ If you try to set a wind threshold higher than 45 Klux, the device signals the error with the lighting of the 3 leds for 3 times.

09.4 SUN THRESHOLD ADJUSTING THROUGH HANDHELD TRANSMITTER

You can change the sun threshold by using a remote control stored in the device. First activate the «SUN FUNCTION» on remote control on the motor channel (read section 9.2 of this manual).

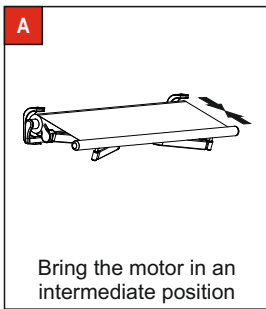

- B.1 USING AN HAND-HELD TRANSMITTER Mod.594**
01. Select the correct radio channel and bring the motor on the intermediate position.
 02. Press **MENU** for about 5 seconds. **rS** appears on the display.
 03. Press 2 times **NEXT**. 02 appears on the display.
 04. Press 1 time **STOP**. The receiver signals the current value. Examples:
if threshold = 07 Klux: ▲ 7 (7 short movements)
if threshold = 18 Klux: ▲ 1 - pause - ▲ 8
if threshold = 20 Klux: ▲ 2 - pause - ▲ 1 long
 05. Using **PREV** and **NEXT** to set the new value (from 1 Klux at 45 Klux. From factory set to 16 Klux).
Examples:
for threshold 07 Klux: (0 time PREV)-7 timesNEXT
for threshold 18 Klux: 1 time PREV-8 times NEXT
for threshold 20 Klux: 2 times PREV-(0 time NEXT)
 06. Press 1 time **STOP**. The receiver signal the new value.

- B.2 USING AN HAND-HELD TRANSMITTER Mod.593**
01. Bring the motor to the intermediate position.
 02. While press **STOP** also press **PROG** for until the LED lights up.
 03. Press twice **DOWN**.
 04. Press once **STOP**. The motor shows the current value Examples:
if threshold = 07 Klux: ▲ 7 (7 short movements)
if threshold = 18 Klux: ▲ 1 - pause - ▲ 8
if threshold = 20 Klux: ▲ 2 - pause - ▲ 1 long
 05. Using **UP** and **DOWN** to set the new value (from 1 Klux at 45 Klux. From factory set to 16 Klux).
Examples:
for threshold 07 Klux: (0 time PREV) - 7 times NEXT
for threshold 18 Klux: 1 time PREV - 8 times NEXT
for threshold 20 Klux: 2 times PREV - (0 time NEXT)
 06. Press 1 time **STOP**. The receiver signal the new value.

09.5 VISUAL SIGNALS ASSOCIATED TO SUN FUNCTION

LED Sun → **RED**: the function is not active or wind alarm in progress (the sun function is temporarily disables)
LED Sun → **OFF**: the intensity of the sun is below the set threshold
LED Sun → **GREEN**: the intensity of the sun is above the set threshold

The "LED manoeuvre" provides information on the latest manoeuvre performed automatically by the device:
LED Manoeuvre → **OFF**: an automatic upward movement was performed for absence of sun
LED Manoeuvre → **GREEN**: an automatic downward movement was performed for presence of sun
LED Manoeuvre → **SLOW FLASHES**: the device is just turned on or is just exit from wind alarm and has not yet made any automatic operation concerning the sun
LED Manoeuvre → **FAST FLASHES**: wind alarm in progress

10. ANEMOMETRIC TEST

The device is provided with a diagnosis function of the wind sensor. If, for about 24 hours the wind sensor does not generate any valid pulse, the device commands an automatic upward manoeuvre, suspends all other activities and indicates the fault by flashing the LEDs. The device will come out of this state resuming normal activities only when the wind sensor generates a valid pulse. The factory sets this test "inactive".
To change the setting:

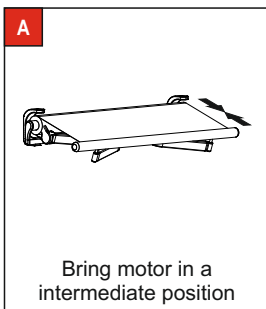

- B.1 USING AN HAND-HELD TRANSMITTER Mod.594**
01. Select the correct radio channel and bring the motor on the intermediate position.
 02. Press **MENU** for about 5 seconds. **rS** appears on the display.
 03. Press 1 TIME **PREV** and 6 times **NEXT**. 16 appears on the display.
 04. Press 1 time **STOP**. The receiver signals the current value.
Function active: ▲ 1 (1 short upward movement)
Function not active: ▼ 1 (1 short descent movement)
 05. Press **PREV** to disable the function (**Of** appears on the display) or **NEXT** to enable the function (**On** appears on the display). Factory set is **Of**.
 06. Press 1 time **STOP**. The receiver signal the new value.
Function active: ▲ 1 - **Function not active:** ▼ 1

- B.2 USING AN HAND-HELD TRANSMITTER Mod.593**
01. Bring the motor to the intermediate position.
 02. While press **STOP** also press **PROG** for until the LED lights up.
 03. Press once **UP** and 6 times **DOWN**.
 04. Press 1 time **STOP**. The receiver signals the current value.
Function active: ▲ 1 (1 short upward movement)
Function not active: ▼ 1 (1 short descent movement)
 05. Press **DOWN** to disable the function
Press **UP** to enable the function
 06. Press 1 time **STOP**. The receiver signal the new value.
Function active: ▲ 1 - **Function not active:** ▼ 1

11. RESET

 This procedure restore the factory condition. This procedure should only be performed by qualified service personnel. After performing the reset procedure, the technician must promptly arrange to carry out the installation described in Section 5.

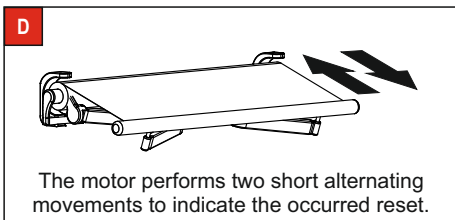
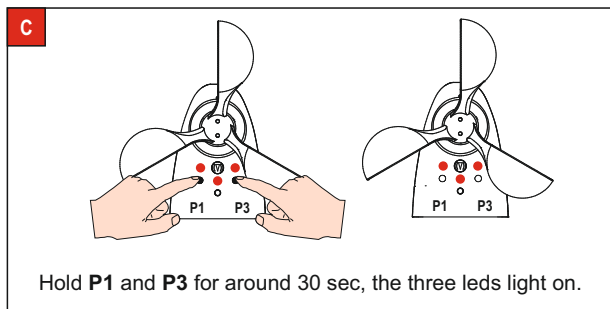
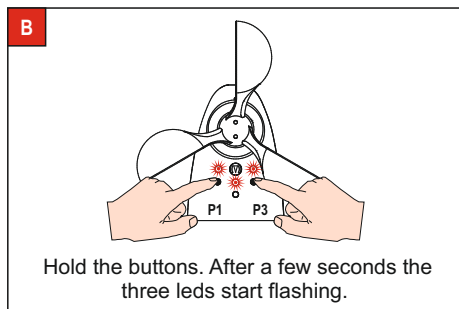
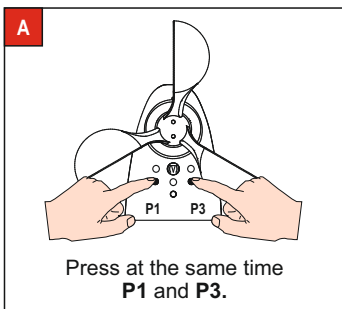

12. FAQ

THE DEVICE DOESN'T WORK.

- ✓ Verify the power supply.
- ✓ Once powered, the device lights LEDs briefly to indicate the proper power supply. If this doesn't happen, it is likely a fault and it may be necessary to replace the device.

WHEN I PRESS UP, THE MOTOR MOVES DOWN.

- ✓ The connection of the wires of the motor windings is reversed. Remove power to the device and reverse the motor wires connected to the wires **3** and **4**.

WHEN I TRY TO STORE THE FIRST REMOTE CONTROL, MOTOR MAKES 2 DOWNWARD MOVEMENTS.

- ✓ Be sure to have correctly done the memorization procedure.
- ✓ The procedure has been made too slowly. When device enters into "transmitter programming" mode, you have 15 sec to press the STOP button of the transmitter you want to store.
- ✓ Verify that battery of the remote control are charged.
- ✓ Try to do the same operation with another transmitter.
- ✓ Check that the environment is not disturbed by other devices working at the same frequency (for example alarms, radio earphones..).
- ✓ Make a reset of the device and try again to memorize the transmitter.
- ✓ The receiver of the device could be damage and could be necessary a device replacement.

WHEN I TRY TO STORE ANOTHER TRANSMITTER, MOTOR MAKES 2 DOWNWARD MOVEMENTS.

- ✓ Verify that stored remote control operates correctly.
- ✓ Be sure to have correctly done the memorization procedure.
- ✓ The device has memorized the maximum number of storable transmitters.
- ✓ The procedure has been made too slowly. When device enters into "transmitter programming" mode, you have 15 sec to press the STOP button of the transmitter you want to store.
- ✓ Verify that battery of the remote control are charged.
- ✓ Try to do the same operation with another transmitter.
- ✓ Check that the environment is not disturbed by other devices working at the same frequency (for example alarms, radio earphones..).
- ✓ Make a reset of the device and try again to memorize the transmitter.
- ✓ The receiver of the device could be damage and could be necessary a device replacement.

WHEN I TRY TO DELETE A TRANSMITTER FROM THE MEMORY, MOTOR MAKES 2 DOWNWARD MOVEMENTS.

- ✓ Be sure to have correctly done the delete procedure.
- ✓ The process has been made too slowly. When the central unit enters into "transmitter setting" mode, there are 15 sec to press the STOP key of the transmitter to store.
- ✓ The device has only one transmitter in its memory: this cannot be deleted!

IN PRESENCE OF WIND, THE UPWARD MOVEMENT IS NOT COMMANDED.

- ✓ Wind threshold is too high. Adjust the threshold.
- ✓ The device could be installed in a position little exposed to the wind.
- ✓ The wind sensor may be damaged. Check the functioning by turning the cups to simulate the presence of the wind and make sure that device enter in "wind alarm".

IN PRESENCE OF WIND, THE UPWARD MOVEMENT IS COMMANDED BUT IN PRESENCE OF SUN THE DOWNWARD MOVEMENT IS NOT COMMANDED

- ✓ The device is in "Wind alarm".
- ✓ Sun threshold is too high. Adjust the threshold.
- ✓ The device could be installed in a position little exposed to the sun, or some object obstructs the proper detection of the sun.
- ✓ Sun function is deactive.
- ✓ The sun sensor may be damaged. Check functionality by checking that "sun LED" blinks quickly once you apply a warm light source at the oval on the device.



All rights reserved.
STAFER S.p.a. - via Malpighi, 9 - 48018 Faenza (RA) ITALY
Tel. (+39) 0546.624811 - Fax. (+39) 0546.623141 - www.stafer.com

