

USER MANUAL:
Sun/wind device for 1 motor / 2 motors

591.K.FS.00

591.K.F2.00

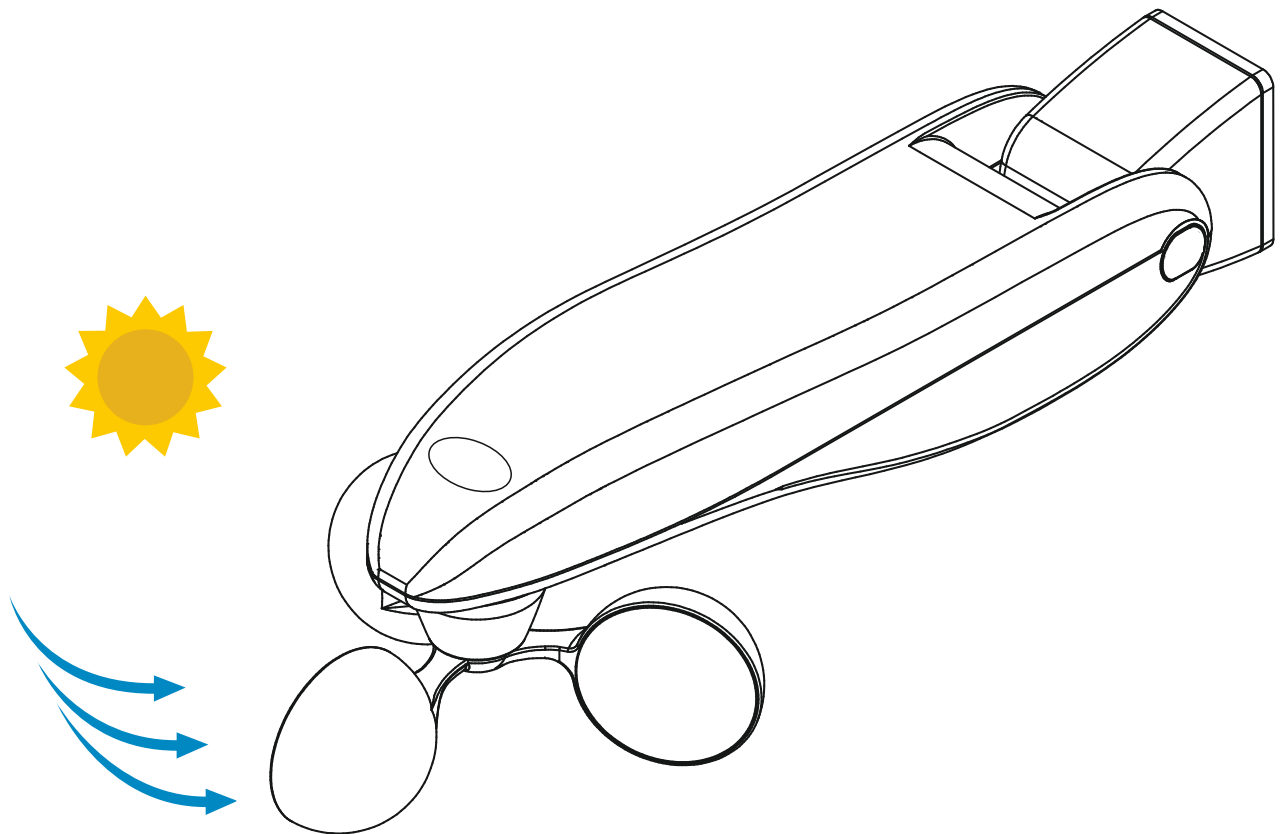

Dear customer, thank you for purchasing a STAFER product. This guide contains information about the product use. Before the product installation and use, please read carefully this guide and keep it for future reference.

591.K.FS.00 / 591.K.F2.00 is a sun/wind device studied to command tubular motor with mechanical limit switch powered by main voltage and it is suitable to command awnings, roller shutters or similar.

591.K.FS.00 / 591.K.F2.00 permits to command the automatic upward movement of the blinds connected to the motor when the wind exceeds the set threshold and to command an automatic lowering when the intensity of sun exceeds the set threshold. These thresholds are set by the factory, but they can be adjusted according to the needs.

WARNING!!

This sensor doesn't protect awning in case of strong and sudden gusts of wind.

In case of weather hazards of this type, make sure that the curtains remain closed!

Stafer S.p.A. declines all responsibility for damage incurred due to weather events not detected by the device.

Any other use beyond the field defined by Stafer S.p.A. is prohibited and involves, as well as the failure to comply with instructions provided in this guide, the cancellation of Stafer S.p.A. liability and warranty. The installer, after the installation of the product, must teach the end user about the working way of the automation and provide him with the user manual.

Index	
01 Warnings	pag. 01
02 Assembly instruction	pag. 02
03 Electrical connection	pag. 03
04 Interfacing with home automation control unit	pag. 04
05 Wind sensor	pag. 04
05.1 How to modify the wind threshold	
05.2 Visual signals associated with the wind sensor	
05.3 Forced exit from the wind alarm	
06 Sun function	pag. 05
06.1 Activation/deactivation of sun function	
06.2 How to modify the sun threshold	
06.3 Visual signals associated with the sun sensor	
07 Operating logic of command buttons	pag. 06
08 ANEMOMETRIC TEST function	pag. 06
09 Reset	pag. 07
10 FAQ	pag. 07

Technical specifications

✓ Power supply:	120 o 230 Vac, 50/60 Hz
✓ Dimensions:	236 x 54 x 73 mm
✓ Weight:	200 gr
✓ Working temperature:	from -20 to +55 °C
✓ Wind threshold:	from 10 to 35 Km/h
✓ Sun threshold:	from 1 to 45 Klux

Environmental conservation!!

STAFER uses packaging recyclable materials. Dispose materials on the proper containers, complying with the law in force in your locality. This product may have substances that are polluting for the environment and dangerous for the health.

At the end of the product life cycle, carefully comply with the waste disposal rules. It is strictly forbidden to dispose the product on the domestic waste.



01. WARNINGS. PAY ATTENTION!

Important safety instructions!

01.1 WARNING FOR SAFETY

- ✓ Incorrect installation can cause serious injuries.
- ✓ Keep these instructions for future maintenance work and disposal of the product.
- ✓ All the product installation, connection, programming and maintenance operations must be carried out only by a qualified and skilled technician, who must comply with laws, provisions, local regulations and the instructions given in this manual.
- ✓ The wiring must comply with current CEI standards. The final electrical system must be created only by the electrician.
- ✓ Some applications require hold-to-run operation and can exclude the use of radio controls or require particular safety devices.
- ✓ To prevent potentially dangerous situations, check the operating condition of the roller shutter/awning regularly.

01.2 WARNING FOR INSTALLATION

- ✓ Read the technical specifications on the paragraph "Technical specifications" to evaluate the operating limits of the product.
- ✓ Before installing the product, check the compatibility with the associated devices and accessories.
- ✓ The motor connected to the device must be of the type "mechanical limit switches", without any electronic control; The motor must be of adequate power to the load (check the nameplate data on the motor).
- ✓ Check that the package is intact and has not been damaged in transit.
- ✓ A heavy shock and the use of unsuitable tools can cause the damage of the external or internal parts of the product.
- ✓ Do not pierce or tamper with the product in any way. Do not modify or replace parts without the manufacturer's permission.
- ✓ Check that the place chosen for the installation of the product permits the same wind exposure of the blind to be automated.
- ✓ Check that the place chosen for the installation is made by solid material and can ensure a stable fixation.
- ✓ Do not install the product near heat sources (such as chimneys, etc....).
- ✓ Adjust the inclination of the device to have the blades positioned horizontally.
- ✓ The blades for the wind detections must be faced downward. The blades must be free to rotate without obstruction.
- ✓ Check that the device is placed in a protected position from accidental impact with other object (e.g. branches, etc.).
- ✓ The power cable must be positioned in such a way that it does not come into contact with moving parts.
- ✓ Do not use abrasive or solvent product for cleaning the device; do not clean using water or high-pressure cleaners.
- ✓ For your safety, do not work near the winding roller while the motor is powered.

01.3 WARNING FOR USE

- ✓ The product is not intended to be used by persons (including children) with reduced physical, sensory or mental capabilities, or lack of experience and knowledge, unless they are supervised or given instructions about the product way of use by a person responsible for their safety.
- ✓ Check the automation during the movement and keep people at a safe distance, until the movement ends.
- ✓ Do not allow children to play with the appliance or with the fixed control devices.
- ✓ Do not operate the blind when maintenance operations are being carried out (e.g. window cleaning, etc.). If the control device is automatic, disconnect the motor from the power line.

02. ASSEMBLY INSTRUCTIONS

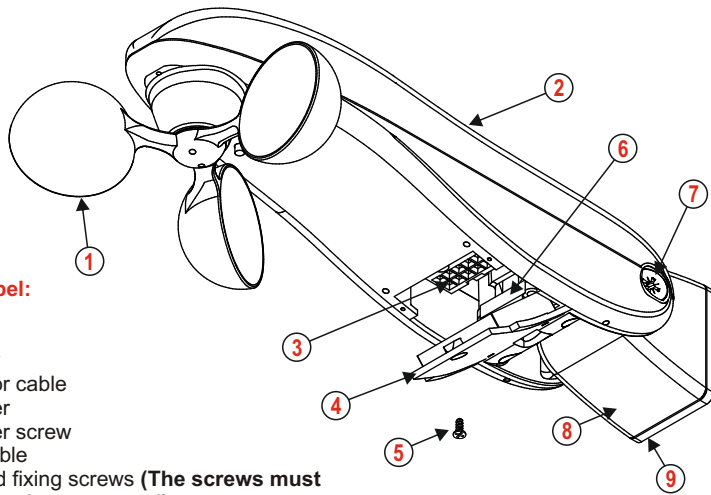

Components label:

- (1) Blades
- (2) Sensor body
- (3) Connector for cable
- (4) Closing cover
- (5) Closing cover screw
- (6) Retaining cable
- (7) Adjusting and fixing screws (The screws must never be completely unscrewed)
- (8) Wall fixing
- (9) Wall support

02.1 BUTTON AND LED DIAGRAM

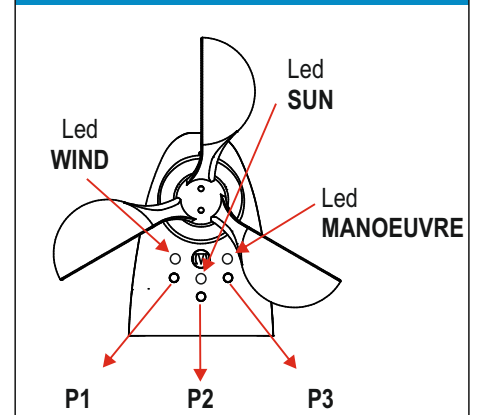

02.2 FIXING SYSTEM

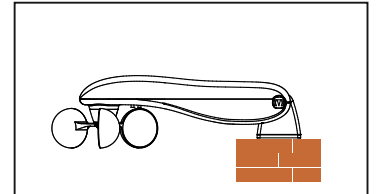
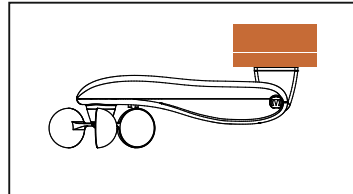
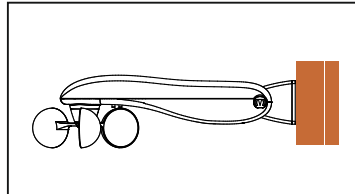
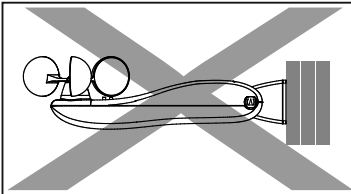

02.3 MOUNTING INSTRUCTIONS



WARNING: Adjusting and fixing screws (7) must never be completely unscrewed

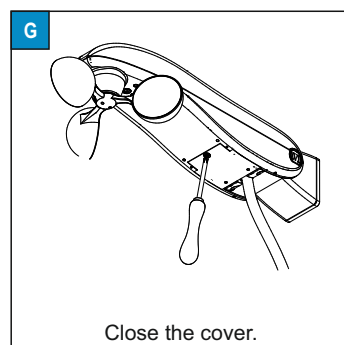
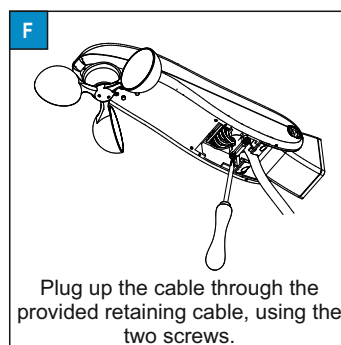
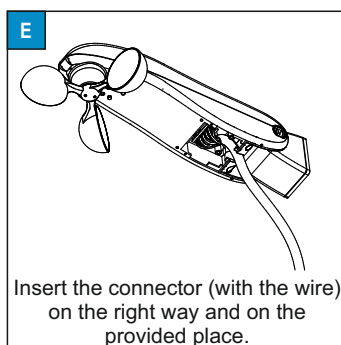
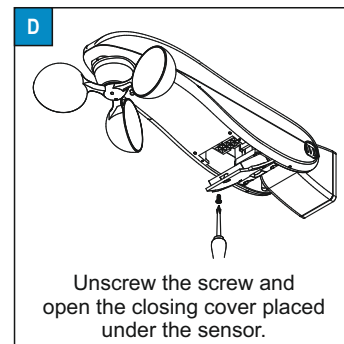
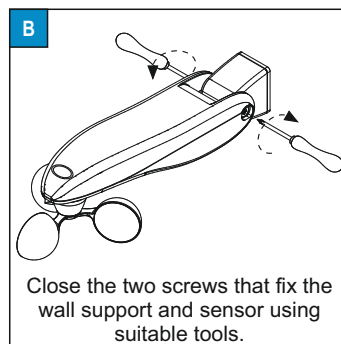
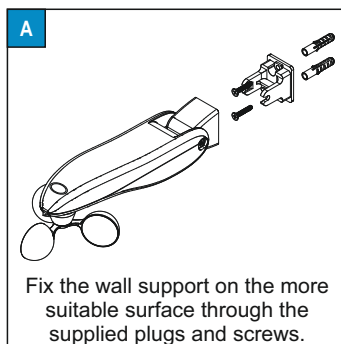

Notes:

- ✓ the product has been studied to be installed with the blades facing downward. Moreover, the body sensor must be adjusted horizontally (the use of a bubble level can simplify the operation); the wall bracket with tilting angle $\pm 90^\circ$ allows to mount the sensor even on no-vertical structures.
- ✓ the hole interaxis is 30 mm.

03. ELECTRICAL CONNECTION

- ⚠ Make connections with power supply disconnected.
- ✓ Check that the power supply does not depend from electrical circuits for lighting.
- ✓ Always connect the motor to the grounding system (yellow/green).
- ✓ The supply line must be equipped with a circuit breaker. The supply line must be fitted with a device with a voltage category III, i.e. the distance between the contacts must be of 3,5 mm at least.
- ✓ The product doesn't provide any protection against overloads or short circuits. Provide the supply line with an adequate protection to the load, for example a fuse of maximum value 3,15A (for 591KFS00) or 6,3A (for 591KF200).
- ✓ The section of the connecting cables must be proportionate to their length and to the absorption of the load, and in any case not less than 1,5 mm.
- ✓ **You must use buttons with spring return ("hold to run" type), do not use buttons with maintained position.**
- ✓ Command buttons are connected to the main voltage, so they must be properly insulated and protected.
- ✓ **Once the electrical connections are finished, bring the motor/motors to the intermediate position and check that in the "wind alarm" condition the module commands the upward movement to the motor/motors (to exit form the "wind alarm", press any buttons P1, P2 or P3).**

591.K.FS.00

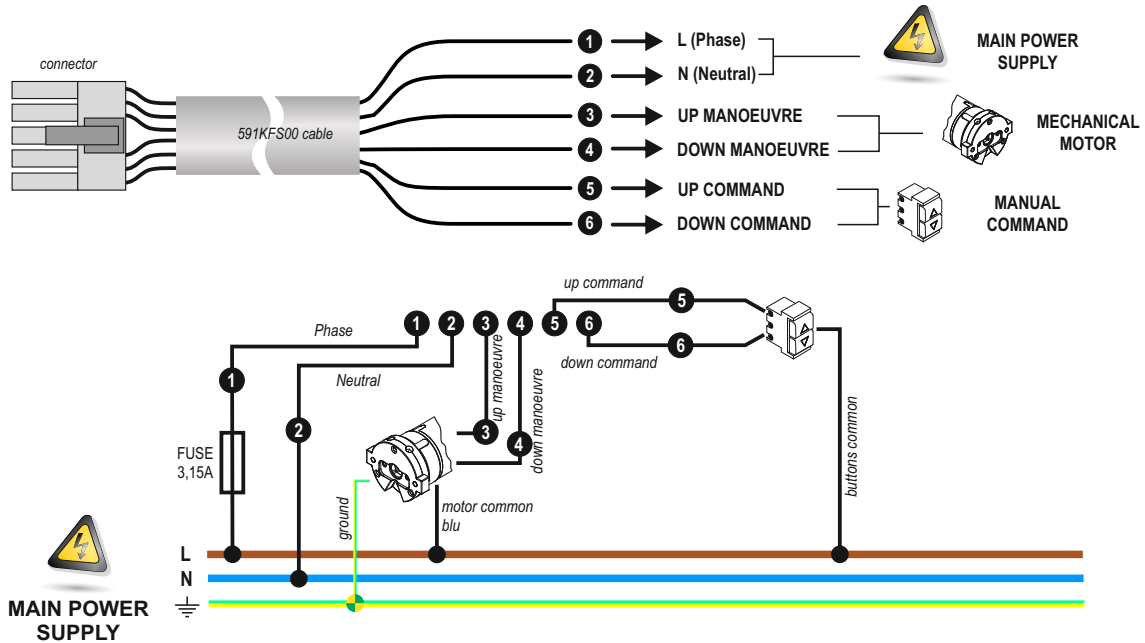

591.K.F2.00

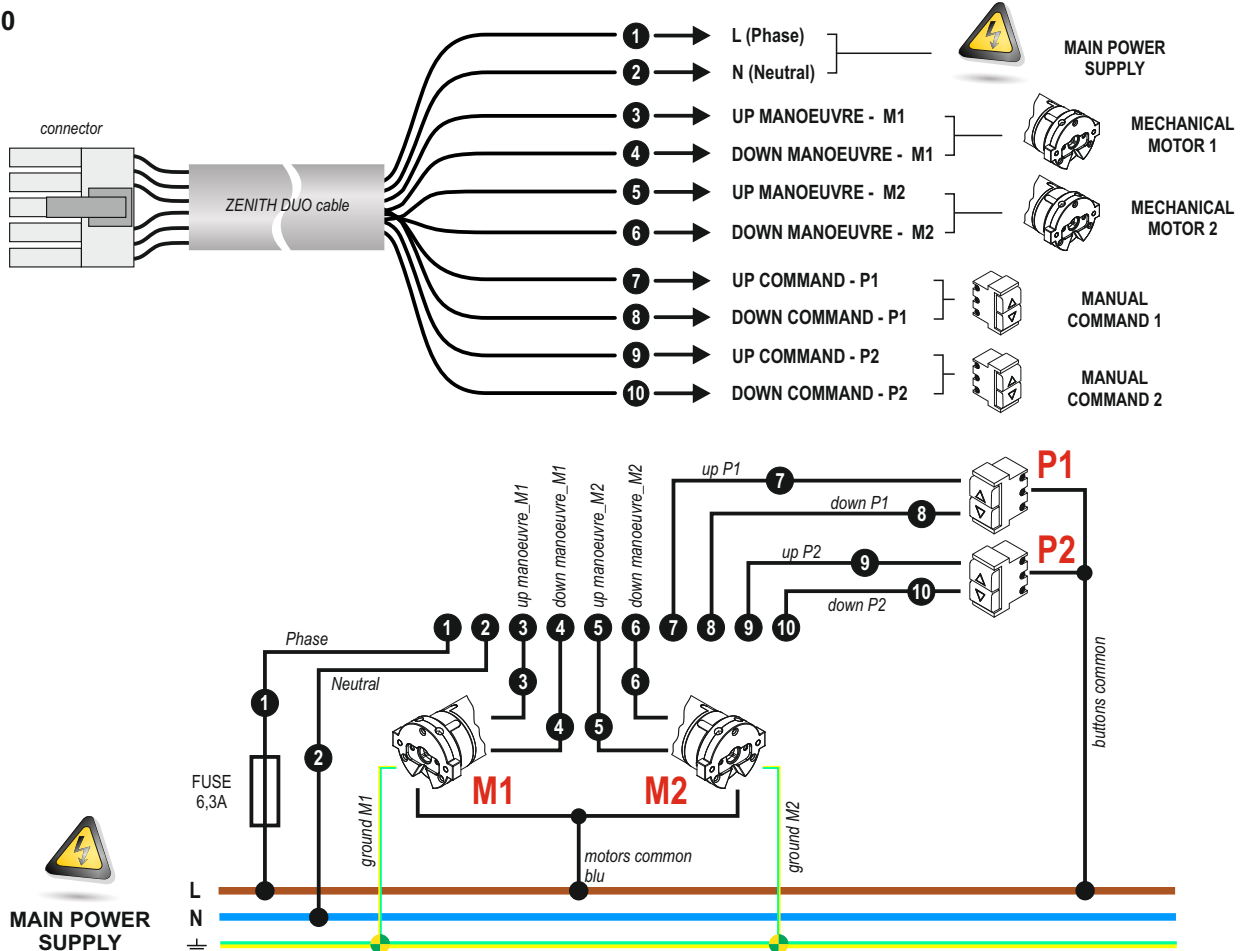

04. INTERFACING WITH HOME AUTOMATION CONTROL UNIT

- ✓ This device can be interfaced to the most widespread home automation control unit through the wires of the command buttons (it is still necessary to check beforehand the compatibility, assessing whether the home automation control unit is able to provide appropriate signals to the device).
- ✓ **Caution:** Before making any connections between your device and the home automation control unit you need to choose the operating logic of the buttons that will best suit your home automation system ("pulse" or "hold to run" logic, see section "Operating logic of the command buttons").
- ✓ If you select the "pulse" operating logic (factory setting), the home automation control unit must be able to generate timed signals on the contacts for the buttons (greater than 0.5 sec to start the manoeuvre, less than 0,5 sec to stop the manoeuvre). If your home automation system does not have this feature, you must set the device to work in "hold to run" logic.
- ✓ Note that the contacts OPEN and CLOSE, belonging to the home automation control unit and connected to the wires of the control buttons on the device, must close on phase.

05. WIND SENSOR

If the wind speed is above the set threshold for at least 3 seconds, an upward movement is commanded to protect the awning (wind alarm). During this phase **all manual commands are disabled**. The device exits from the "wind alarm" if the wind speed keeps below the set threshold for at least 8 minutes. The wind threshold is varying from 10 km/h to 35 km/h. The factory sets the wind threshold at 15 Km/h.

05.1 HOW TO MODIFY THE WIND THRESHOLD

A

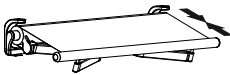

Bring the motor in an intermediate position

B

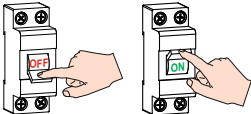

Switch OFF power supply, wait 2 seconds and switch ON power supply

C ⁽¹⁾

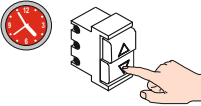

8 x DOWN

Within 15 seconds press DOWN 8 times

D



The motor makes 3 small upward movements

E ⁽²⁾

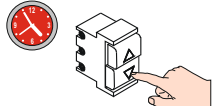

2 x DOWN

Within 15 seconds press DOWN 2 times

F

See Tab. 01



The motor shows the current setting (from 1 to 6 movements)

G ⁽³⁾

WITHIN 15 SECONDS SELECT THE DESIRED SETTING BY PRESSING UP FROM 1 TO 6 TIMES

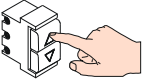
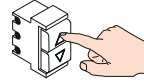
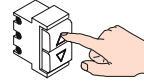
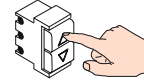
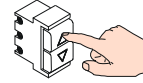
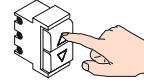
10 Km/h	15 Km/h	20 Km/h	25 Km/h	30 Km/h	35 Km/h
					
1 x UP	2 x UP	3 x UP	4 x UP	5 x UP	6 x UP

H

See Tab. 01



The motor shows the new setting (from 1 to 6 movements)

Tab. 01 - Wind threshold

n° of movements	Threshold
1	10 Km/h
2	15 Km/h
3	20 Km/h
4	25 Km/h
5	30 Km/h
6	35 Km/h

If you try to set a wind threshold higher than 35 Km/h, the device signals the error by commanding 2 downward movements

Notes:

- ✓ (1): the button must be pressed briefly (less than 0.5 sec) and in rapid succession (max 1 seconds between each press and the next).
- ✓ (2): the button must be pressed briefly (less than 0.5 sec) and in rapid succession (max 1 seconds between each press and the next).
- ✓ (3): the button must be pressed briefly (less than 0.5 sec) and in rapid succession. If you don't want to change the setting, wait about 15 seconds without pressing any button.

05.2 VISUAL SIGNALS ASSOCIATED WITH THE WIND SENSOR

LED Wind → **RED**: the wind is above the threshold
 LED Wind → **OFF**: the wind is below the threshold

LED Manoeuvre → **QUICK FLASHES**: the device is in wind alarm and the manual commands are disabled.

05.3 FORCED EXIT FROM WIND ALARM

During the installation phase, it is possible to exit from "wind alarm" without waiting 8 minutes, shortly pressing (less than 1 sec) any of the buttons **P1, P2, P3** on the device.

09. SUN FUNCTION

If the intensity of the sun is above the set threshold for at least 2.5 minutes, an automatic downward manoeuvre is performed; if the intensity of the sun is below the set threshold for at least 18 minutes, an automatic upward manoeuvre is performed. Once an automatic downward manoeuvre for the presence of the sun is performed, the next automatic manoeuvre performed by the device will be an upward movement for absence of sun and so on. The user can in any case operate the awning, the manual control don't affects the operating logic of the sun sensor. The sun threshold is variable from 1 to 45 Klux. The factory sets the sun threshold to 16 Klux.

09.1 ACTIVATION/DEACTIVATION OF SUN FUNCTION

<p>A ⁽¹⁾ TO ACTIVATE:</p>  <p>4 x DOWN</p> <p>Press 4 times DOWN</p>	<p>B</p>  <p>The motors indicate that the setting has been changed.</p>	<p>A ⁽¹⁾ TO DISABLE:</p>  <p>4 x UP</p> <p>Press 4 times UP</p>	<p>B</p>  <p>The motors indicate that the setting has been changed.</p>
--	---	---	---

09.2 HOW TO MODIFY THE SUN THRESHOLD

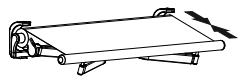
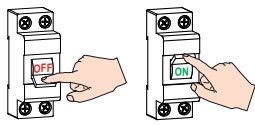
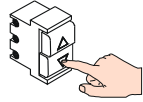
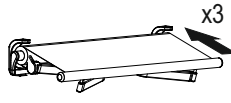
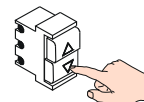
<p>A</p>  <p>Bring the motor in an intermediate position</p>	<p>B</p>  <p>Switch OFF power supply, wait 2 seconds and switch ON power supply</p>	<p>C ⁽¹⁾</p>  <p>8 x DOWN</p> <p>Within 15 seconds press DOWN 8 times</p>	<p>D</p>  <p>The motor makes 3 small upward movements</p>	<p>E ⁽¹⁾</p>  <p>3 x UP</p> <p>Within 15 seconds press UP 3 times</p>
---	---	---	--	---

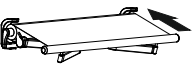
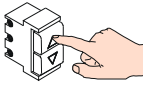
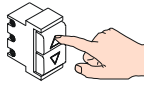
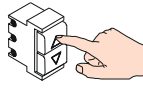
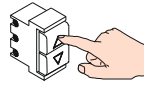
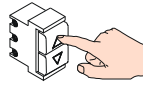
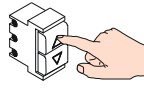
<p>F</p> <p>See Tab. 02</p>  <p>The motor shows the current setting (from 1 to 6 movements)</p>	<p>G ⁽²⁾ WITHIN 15 SECONDS SELECT THE DESIRED SETTING BY PRESSING UP FROM 1 TO 6 TIMES</p>					
<p>1 Klux</p>  <p>1 x UP</p>	<p>8 Klux</p>  <p>2 x UP</p>	<p>15 Klux</p>  <p>3 x UP</p>	<p>22 Klux</p>  <p>4 x UP</p>	<p>30 Klux</p>  <p>5 x UP</p>	<p>45 Klux</p>  <p>6 x UP</p>	

H

See Tab. 02

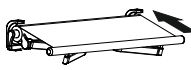

The motor shows the new setting (from 1 to 6 movements)

Tab. 02 - Sun threshold

n° of movements	Threshold
1	1 Klux
2	8 Klux
3	15 Klux
4	22 Klux
5	30 Klux
6	45 Klux

If you try to set a sun threshold higher than 45 Klux, the device signals the error by commanding 2 downward movements

Notes:

- ✓ (1): the button must be pressed briefly (less than 0.5 sec) and in rapid succession (max 1 seconds between each press and the next).
- ✓ (2): the button must be pressed briefly and in rapid succession. If you don't want to change the setting, wait about 15 seconds without pressing any button.

09.3 VISUAL SIGNALS ASSOCIATED WITH THE SUN SENSOR

<p>LED Sun → RED: the function is not active</p> <p>LED Sun → OFF: the sun is below the set threshold</p> <p>LED Sun → GREEN: the sun is above the set threshold</p>	<p>«LED manoeuvre» provides information on the latest automatic manoeuvre performed by the device:</p> <p>LED Manoeuvre → OFF: an automatic upward movement was performed for absence of sun</p> <p>LED Manoeuvre → GREEN: an automatic downward movement was performed for presence of sun</p> <p>LED Manoeuvre → QUICK FLASHES: the device is just turned on or is just exit from wind alarm and has not yet made any automatic operation concerning the sun</p>
---	---

07. OPERATING LOGIC OF COMMAND BUTTONS

This device provides the possibility to choose one of the following operating logics for the command buttons :

“Pulse” logic

This is the default mode from the factory. The motor moves up (down) if the relevant contact is closed on phase for at least 0.5 sec, the motor will stop if any one of the two contacts is closed briefly (less than 0.5 sec).

“Hold to run” logic

The motor moves up (down) if the relevant contact is closed on phase for at least 0.5 sec, the motor stops when contact is open.

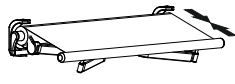
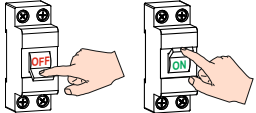
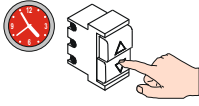
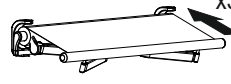
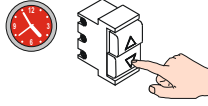
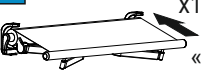
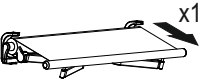
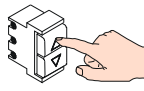
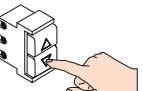
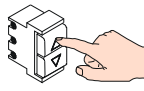
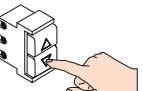
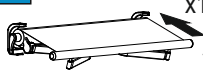
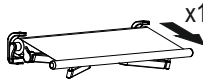
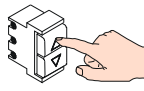
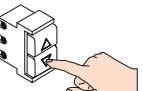



<p>A</p>  <p>Bring the motor in an intermediate position</p>	<p>B</p>  <p>Switch OFF power supply, wait 2 seconds and switch ON power supply</p>	<p>C ⁽¹⁾</p>  <p>8 x DOWN</p> <p>Within 15 sec press DOWN 8 times</p>	<p>D</p>  <p>The motor makes 3 small upward movements</p>	<p>E ⁽²⁾</p>  <p>4 x DOWN</p> <p>Within 15 sec press DOWN 4 times</p>	
<p>F</p>  <p>x1 «Hold to run»</p>  <p>x1 «Pulse»</p> <p>The motor signals the current setting</p>	<p>G ⁽³⁾ WITHIN 15 SECONDS SELECT THE DESIRED SETTING BY PRESSING:</p> <table border="1"> <tr> <td data-bbox="459 712 692 940"> <p>«Hold to run»</p>  <p>UP</p> </td> <td data-bbox="746 712 979 940"> <p>«Pulse»</p>  <p>DOWN</p> </td> </tr> </table>		<p>«Hold to run»</p>  <p>UP</p>	<p>«Pulse»</p>  <p>DOWN</p>	<p>H</p>  <p>x1 «Hold to run»</p>  <p>x1 «Pulse»</p> <p>The motor signals the new setting</p>
<p>«Hold to run»</p>  <p>UP</p>	<p>«Pulse»</p>  <p>DOWN</p>				

- Notes:**
- ✓ (1) : the button must be pressed briefly (less than 0.5 sec) and in rapid succession (max 1 seconds between each press and the next)
 - ✓ (2) : the button must be pressed briefly (less than 0.5 sec) and in rapid succession (max 1 seconds between each press and the next)
 - ✓ (3) : the button must be pressed briefly. If the setting is the desired one, wait 15 sec without pressing any button

08. ANEMOMETRIC TEST

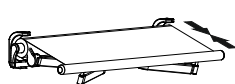
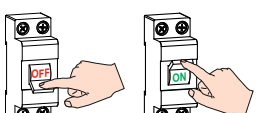
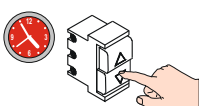
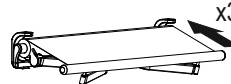
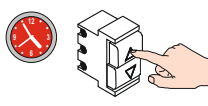
The device is provided with a diagnosis function of the wind sensor. If, for about 24 hours the wind sensor does not generate any valid pulse, the device commands an automatic upward manoeuvre, suspends all other activities and indicates the fault by flashing the LEDs. The device will come out of this state resuming normal activities only when the wind sensor generates a valid pulse. The factory sets this test "inactive".

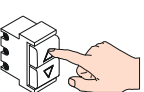
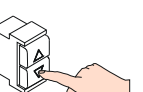
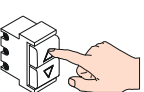
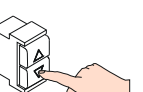
To change the setting:

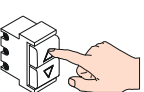
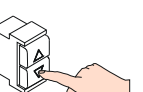
<p>A</p>  <p>Bring the motor in an intermediate position</p>	<p>B</p>  <p>Switch OFF power supply, wait 2 seconds and switch ON power supply</p>	<p>C ⁽¹⁾</p>  <p>8 x DOWN</p> <p>Within 15 sec press DOWN 8 times</p>	<p>D</p>  <p>The motor makes 3 small upward movements</p>	<p>E ⁽²⁾</p>  <p>5 x UP</p> <p>Within 15 sec press UP 5 times</p>	
<p>F</p>  <p>x1 «Active»</p>  <p>x1 «Inactive»</p> <p>The motor signals the current setting</p>	<p>G ⁽³⁾ WITHIN 15 SECONDS SELECT THE DESIRED SETTING BY PRESSING:</p> <table border="1"> <tr> <td data-bbox="459 1769 692 1998"> <p>«Active»</p>  <p>UP</p> </td> <td data-bbox="746 1769 979 1998"> <p>«Inactive»</p>  <p>DOWN</p> </td> </tr> </table>		<p>«Active»</p>  <p>UP</p>	<p>«Inactive»</p>  <p>DOWN</p>	<p>H</p>  <p>x1 «Active»</p>  <p>x1 «Inactive»</p> <p>The motor signals the new setting</p>
<p>«Active»</p>  <p>UP</p>	<p>«Inactive»</p>  <p>DOWN</p>				

- Notes:**
- ✓ (1) : the button must be pressed briefly (less than 0.5 sec) and in rapid succession (max 1 seconds between each press and the next)
 - ✓ (2) : the button must be pressed briefly (less than 0.5 sec) and in rapid succession (max 1 seconds between each press and the next)
 - ✓ (3) : the button must be pressed briefly. If the setting is the desired one, wait 15 sec without pressing any button

09. RESET



This procedure restore the factory condition. This procedure should only be performed by qualified service personnel.

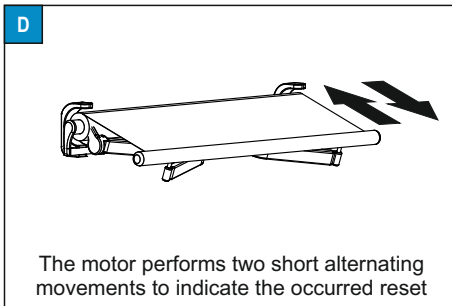
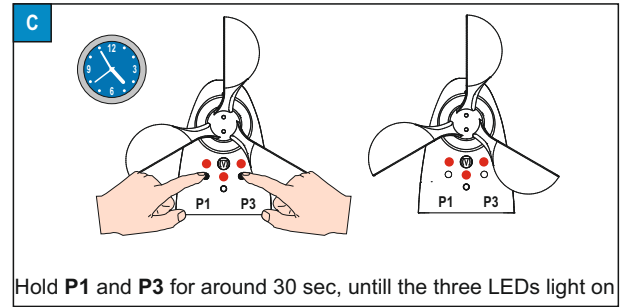
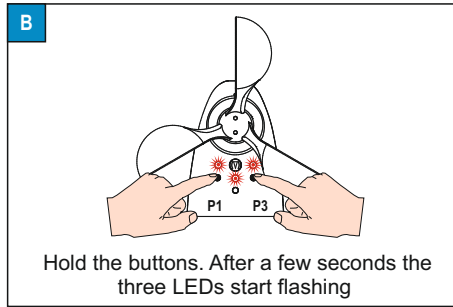
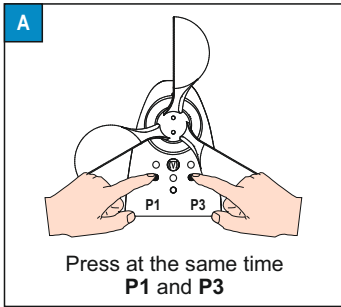

10. FAQ

THE DEVICE DOESN'T WORK.

- ✓ Verify the power supply.
- ✓ Once powered, the device lights LEDs briefly to indicate the proper power supply. If this doesn't happen, it is likely a fault and it may be necessary to replace the device.

WHEN I PRESS UP, THE MOTOR MOVES DOWN.

- ✓ The connection of the wires of the motor windings is reversed. Remove power to the device and reverse the motor wires connected to the wires **3** and **4** (for 591.K.FS.00), **3/4** and **5/6** (for 591.K.F2.00).

IN PRESENCE OF WIND, THE UPWARD MOVEMENT IS NOT COMMANDED.

- ✓ Wind threshold is too high. Adjust the threshold.
- ✓ The device could be installed in a position little exposed to the wind.
- ✓ The wind sensor may be damaged. Check the functioning by turning the cups to simulate the presence of the wind and make sure that device enter in "wind alarm".

IN PRESENCE OF WIND AN UPWARD MOVEMENT IS COMMANDED, BUT IS NOT COMMANDED A DOWNWARD MOVEMENT IN PRESENCE OF SUN.

- ✓ The device is in "Wind alarm".
- ✓ Sun threshold is too high. Adjust the threshold.
- ✓ The device could be installed in a position little exposed to the sun, or some object obstructs the proper detection of the sun.
- ✓ Sun function is deactive.
- ✓ The sun sensor may be damaged. Check functionality by checking that "sun LED" blinks quickly once you apply a light source at the oval on the device.



All rights reserved.
STAFER S.p.a. - via Malpighi, 9 - 48018 Faenza (RA) ITALY
Tel. (+39) 0546.624811 - Fax. (+39) 0546.623141 - www.stafer.com

